

1 TOP VIEW

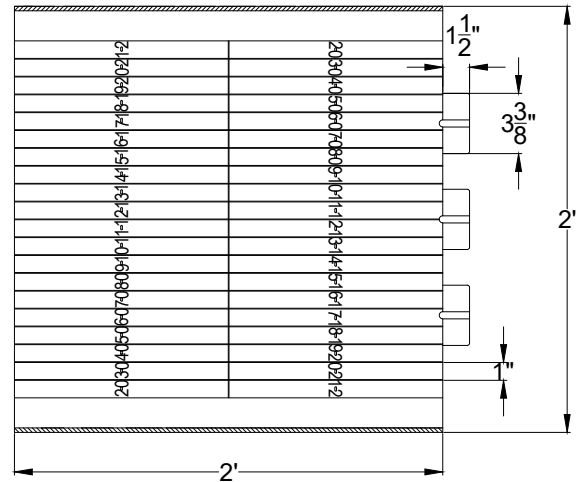

2 BOTTOM VIEW

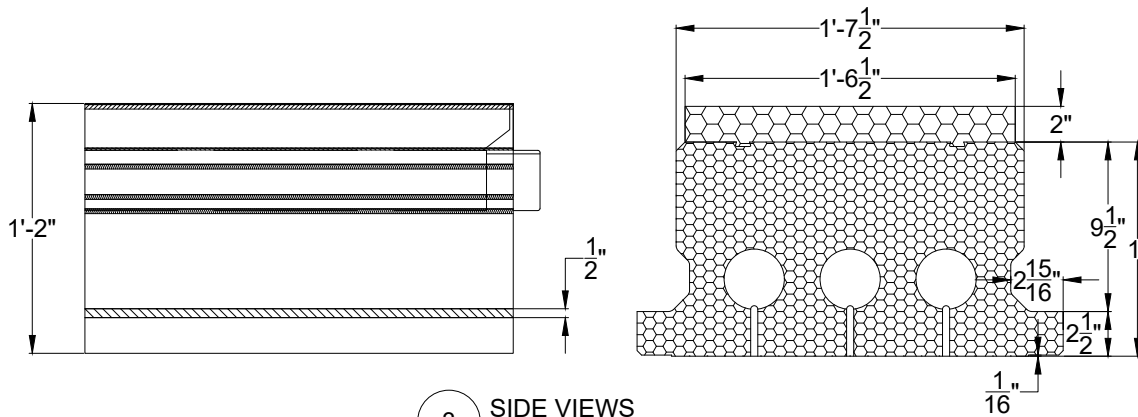

3 SIDE VIEWS

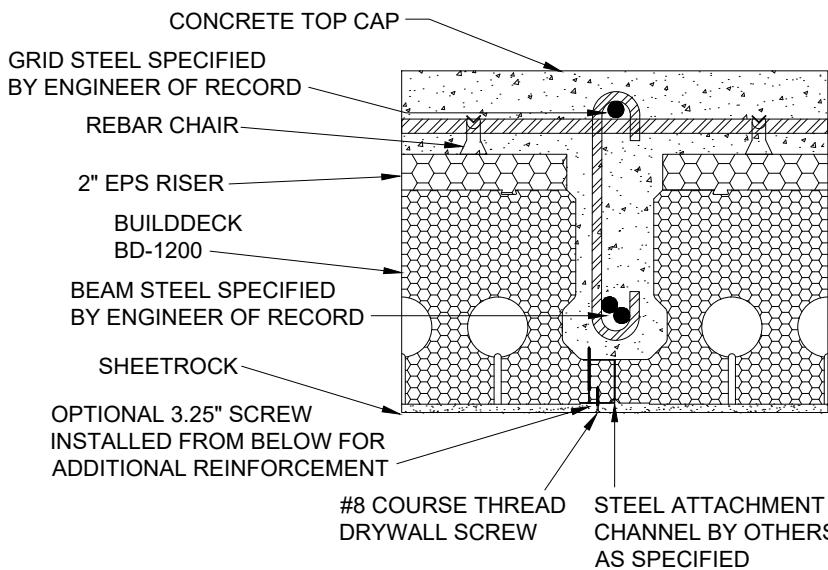

NOTE:
ALL CONCRETE AND STEEL DESIGN MUST BE APPROVED BY THE PROJECT SPECIFIC ENGINEER OF RECORD.

NOTE:
EPS RISERS OF VARYING HEIGHTS MAY BE ADDED TO THE TOP OF BUILDDECK PANELS TO ADJUST BEAM DEPTH ACCORDING TO ENGINEERED SPECIFICATIONS

DATE / REVISION / BY	7-1-23 / 1 / AQ
SCALE	NTS
FILE NAME	1.705 - BD1200