

1 FRONT VIEW  
WITHOUT CAP

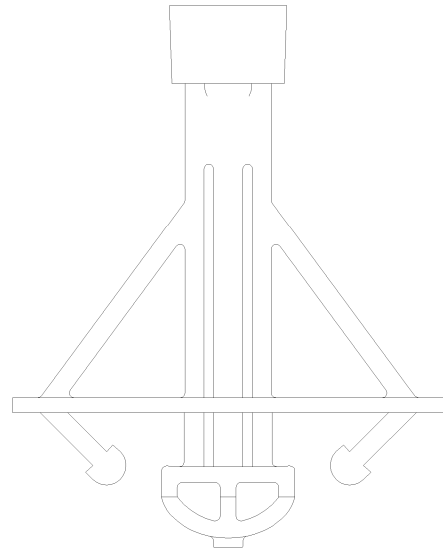

2 FRONT VIEW  
WITH CAP

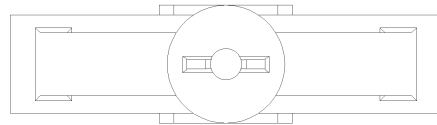

3 TOP VIEW  
WITH CAP

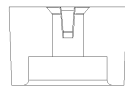
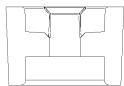
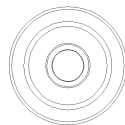
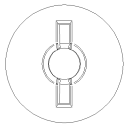

4 TOP AND SIDE VIEW  
CAP

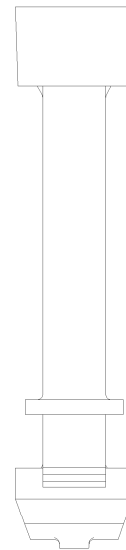

5 SIDE VIEW  
WITH CAP

DATE / REVISION / BY	7-1-23 / 1 / AQ
SCALE	NTS
FILE NAME	1.916 - BBHW